

NOTES:

1. Customer facilities shall comply with Company Standards, the National Electrical Code, and authorities having jurisdiction.
2. Buildings or other facilities shall not be constructed over existing company supply lines, nor shall any company supply lines pass under existing buildings or facilities.
3. Schedule 80 PVC for elbows and above ground facilities are required.
4. Main breaker should be within 2'-0" of meter. Outside wall is recommended.
5. Customer shall install meter enclosure.
6. Minimum 3 ft. clearance between electric meter and gas meter.
7. Any Service greater than 200 amps, consult the Company.

CALL 811 TWO BUSINESS DAYS BEFORE YOU DIG

In locations with underground facilities, the Customer shall notify One Call and shall have One Call locate all underground facilities before digging. It shall be the responsibility of the Customer to stay clear of all underground facilities.

ENTERGY SERVICES, INC.

TYPICAL SINGLE PHASE RESIDENTIAL FLOOD PLAN RAISED FOUNDATION METER ACCESS REQUIREMENTS FOR UNDERGROUND FACILITIES

APPROVED BY: JRH	DATE: 11/07/2012
CHECKED BY: JED	SCALE: NONE
DRAWN BY: krich95	



No. D9-14
PLOT 1=1 SH. 1 OF 1

1	10/12	REVISION FOR DRAWING SS11.7-1	JED	
NO.	DATE:	REVISION	BY:	APPR:

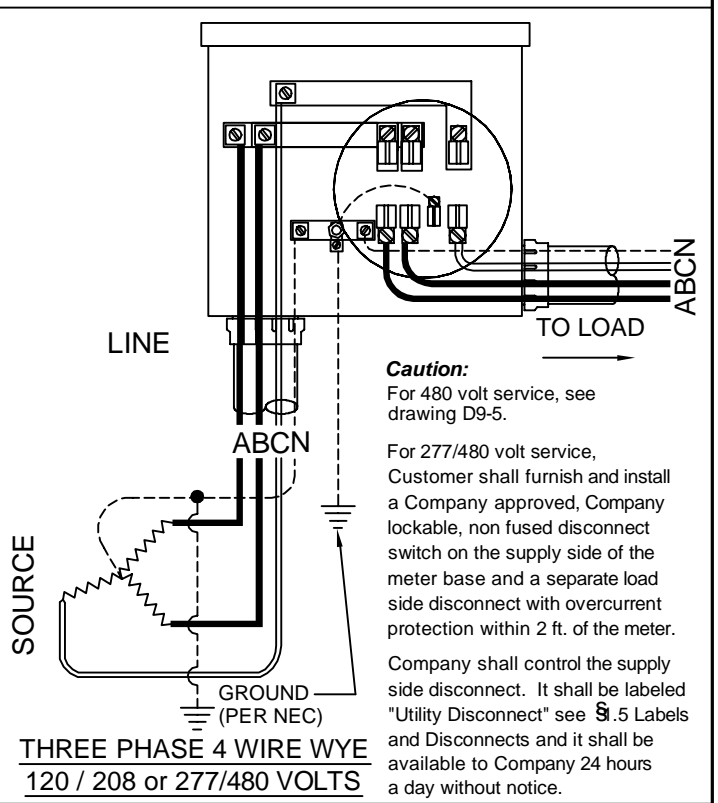
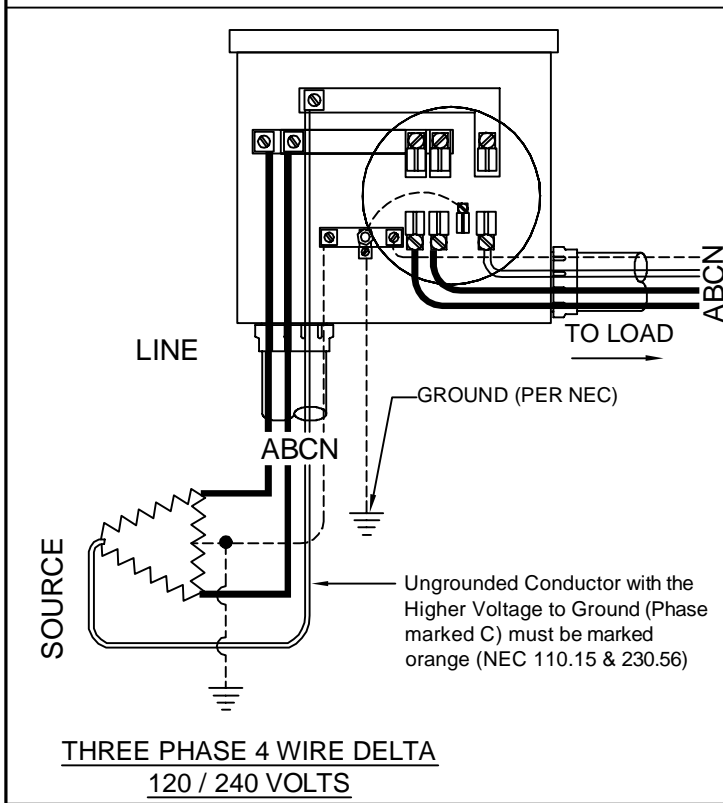
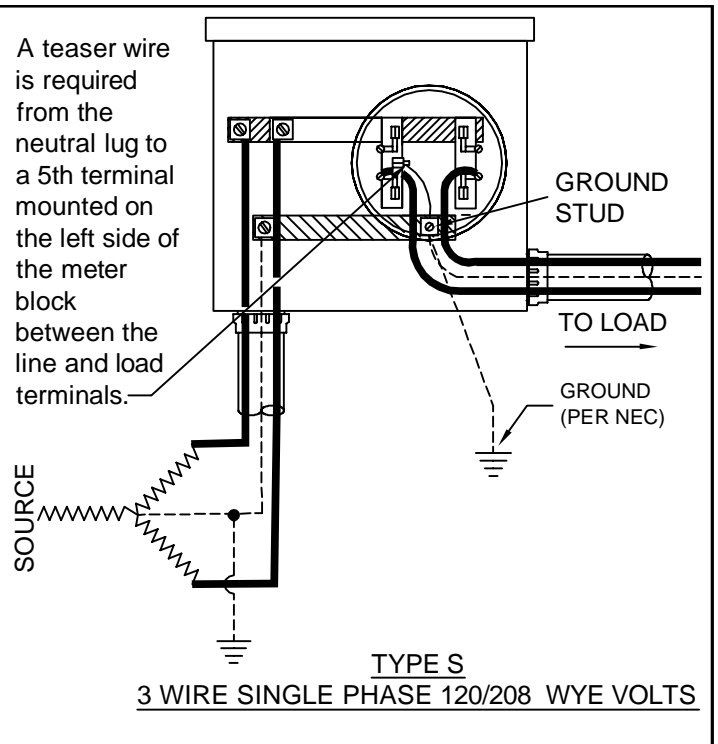
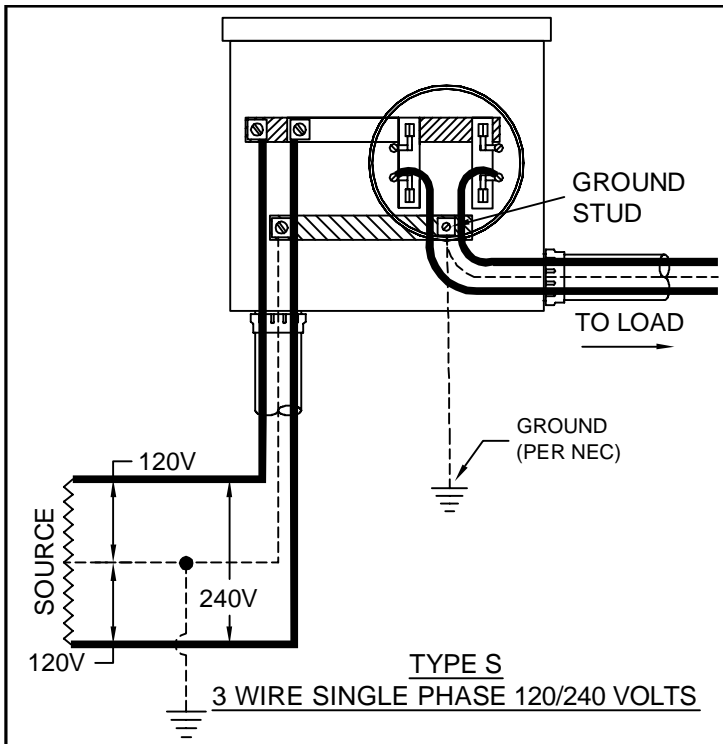

Notes:

1. All diagrams on this drawing show connections when the switch is installed on the right side (see Right Side below) of the meter socket. If the switch is installed on the left side of the meter socket you will need to mirror this diagram (see Left Side below).
2. All sockets, except residential single phase less than 320 Amps, shall have a manual mechanical gang operated bypass switch.
3. Load and supply wires shall not cross in the meter socket.

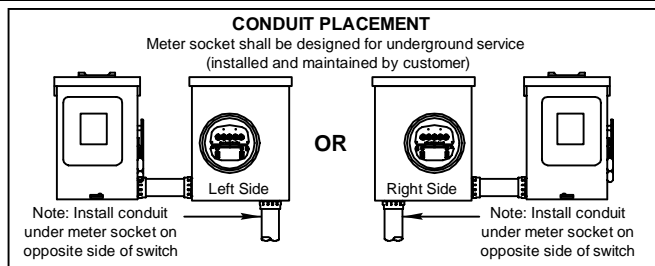

ENTERGY SERVICES, INC.

WIRING DIAGRAM CONNECTIONS FOR UNDERGROUND SELF CONTAINED METERS

APPROVED BY:	JRH	DATE:	01/10/2013
CHECKED BY:	JED	SCALE:	NONE
DRAWN BY:	krich95		

1	01/13	REVISION OF DRAWING SS11.8-2	EJH
NO.	DATE:	REVISION	BY: APPR:

Entergy

No. D9-3

PLOT 1=1 SH. 2 OF 2

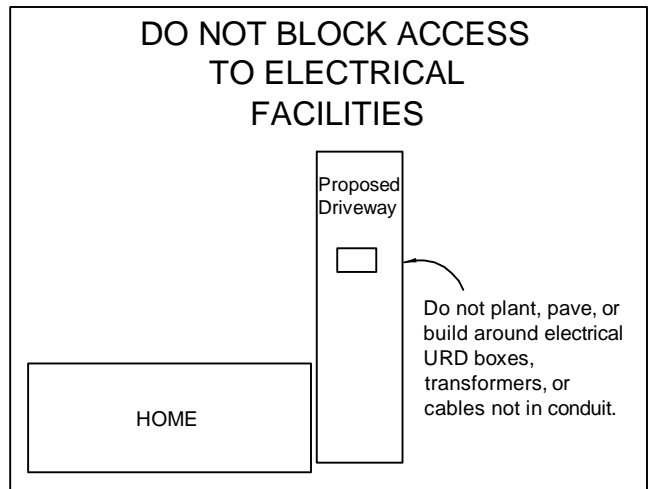
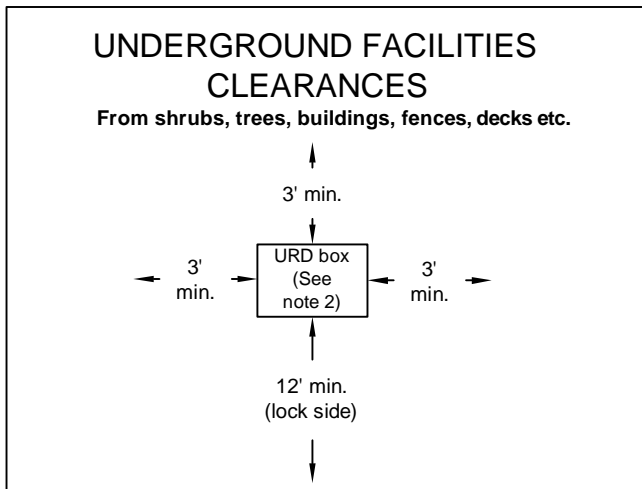
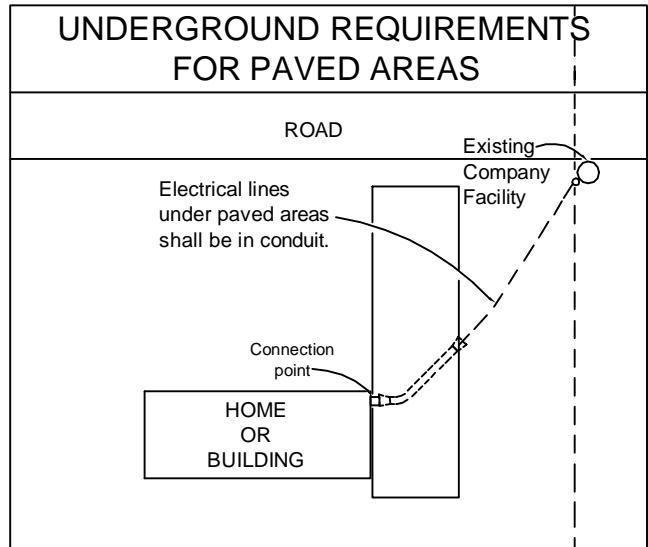
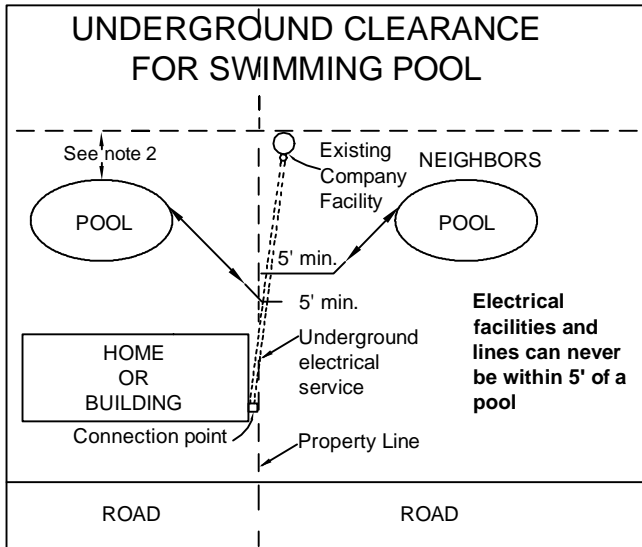

SERVICE CABLE IS NOT ALLOWED BELOW A BUILDING.

Minimum Customer Wiring Size - Residence Single Phase **				
METER SIZE	CONDUIT SIZE	Current carrying & neutral wire size (per NEC)		GROUND WIRE SIZE
		COPPER	ALUMINUM	
100 Amp	2"	#4	#2	#6
200 Amp	2.5" *	2/0	4/0	#4
320 Amp	3"	350	500	#2

* Arkansas locations only allows 2"
** For 3Ø, consult the Company, Commercial/Industrial wire sizes are typically larger.

CALL 811 TWO BUSINESS DAYS BEFORE YOU DIG

In locations with underground facilities, the Customer shall notify One Call and shall have One Call locate all underground facilities before digging. It shall be the responsibility of the Customer to stay clear of all underground facilities.

Notes:

- The Customer is responsible for clearing and maintaining all right of way.
- NEVER** build anything under or over existing electrical lines or facilities. Check with the Company for clearances.
- Contact Company for clearances prior to pool construction.**
- Connection point shall be pre-approved by the Company.
- Transformers must meet requirements of drawing D10-1.
- The Customer shall bear the cost of conduit and its installation.
- Underground service/conduit should be installed separated by not less 24" of well tamped earth from other utilities.
- Conduit color shall be electrical gray or black with red stripes (for continuous below ground conduit). Conduits above the ground and transition elbow or conduit from underground to above ground, shall be schedule 80 PVC or equivalent. Generally, non-metallic conduit installed totally below grade shall be at least Schedule 40 PVC or equivalent. In certain cases, concrete encasement may be required according to Drawings D8-2 and D8-7. All conduits, elbows, fittings, etc. shall be UL approved with an U. L. label.

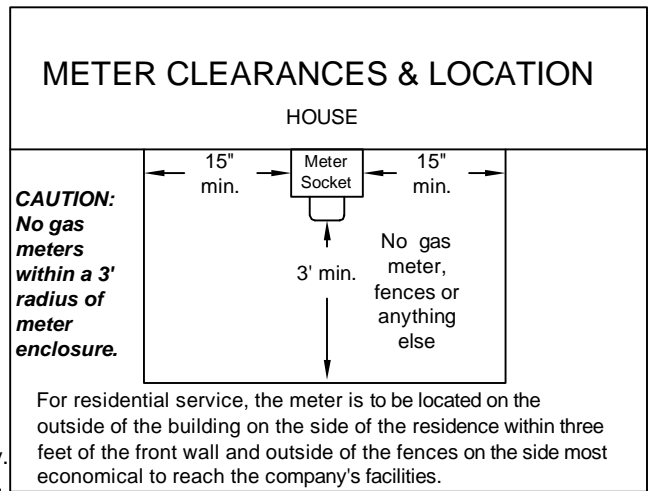

ENTERGY SERVICES, INC.			
UNDERGROUND SERVICE INSTALLATION DETAILS & CLEARANCES			
APPROVED BY:	JRH	DATE:	10/24/2012
CHECKED BY:	JED	SCALE:	None
DRAWN BY:	krich95		
		No.	D8-1
NO.	DATE:	REVISION	BY: APPR:
		PLOT 1=1	SH. 1 OF 1

1	10/12	REVISION OF DRAWING SS8.6-6.	JED	
NO.	DATE:	REVISION	BY:	APPR: