

Siemens, Model # SUAS877-PG
(or **Landis & Gyr # UAS877-PG**)



Eaton-Durham
Model # UTRS223ACH



Midwest
UTRS223AMEP

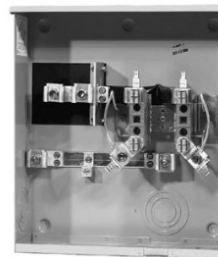

Milbank
Model # U1980-O

These are some examples of the single meter sockets we require for underground service. Our cable comes in on the bottom and goes straight into the terminal lugs. No Wire Bending Required.

Socket/Breaker combination panels with this design are also acceptable and shown on our web-page under "Meters".

Effective June, 2008

Revised April, 2013

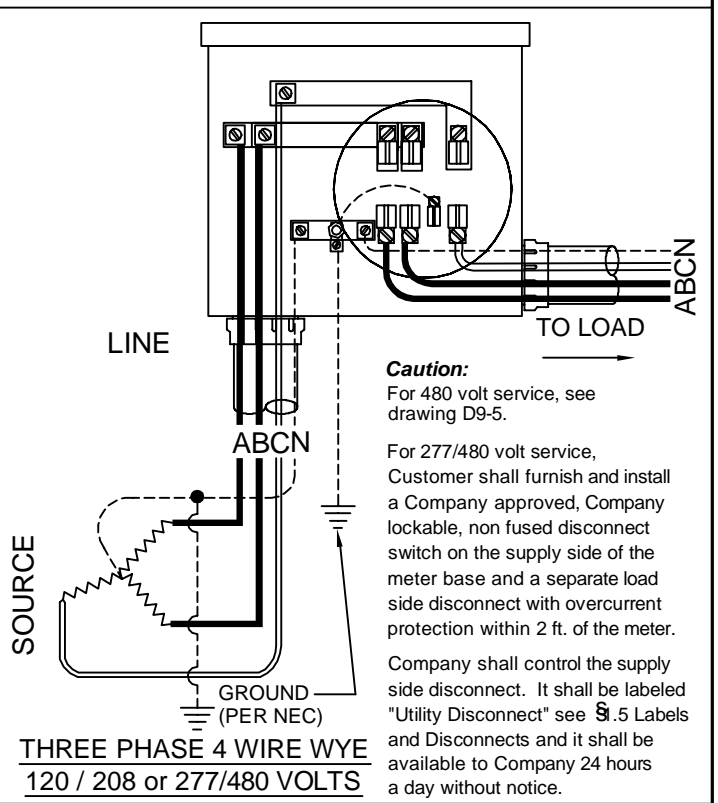
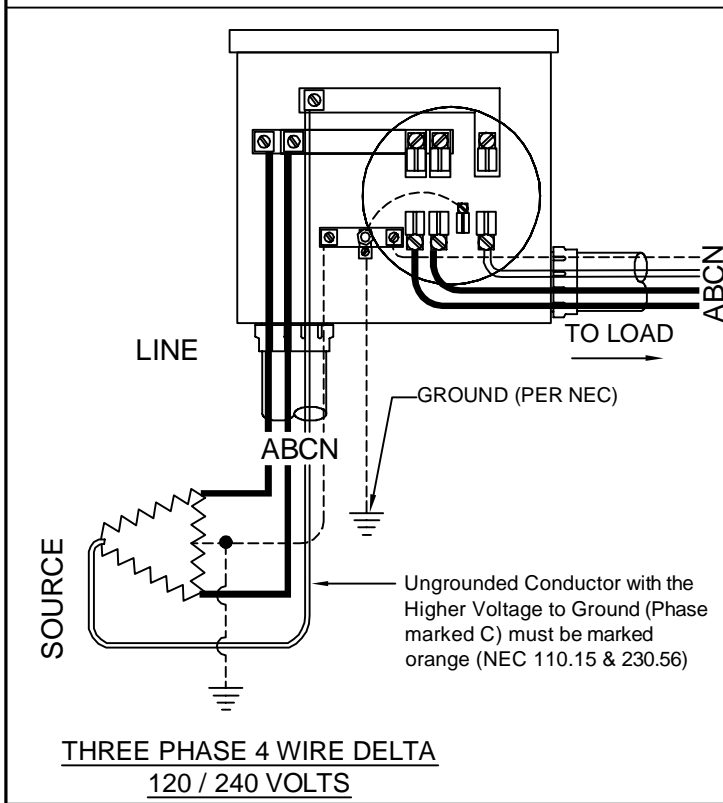
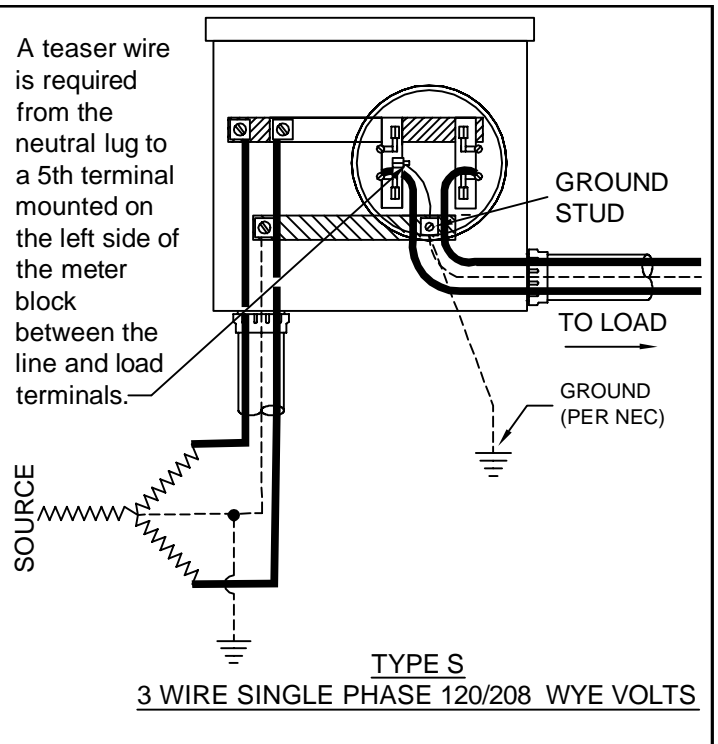
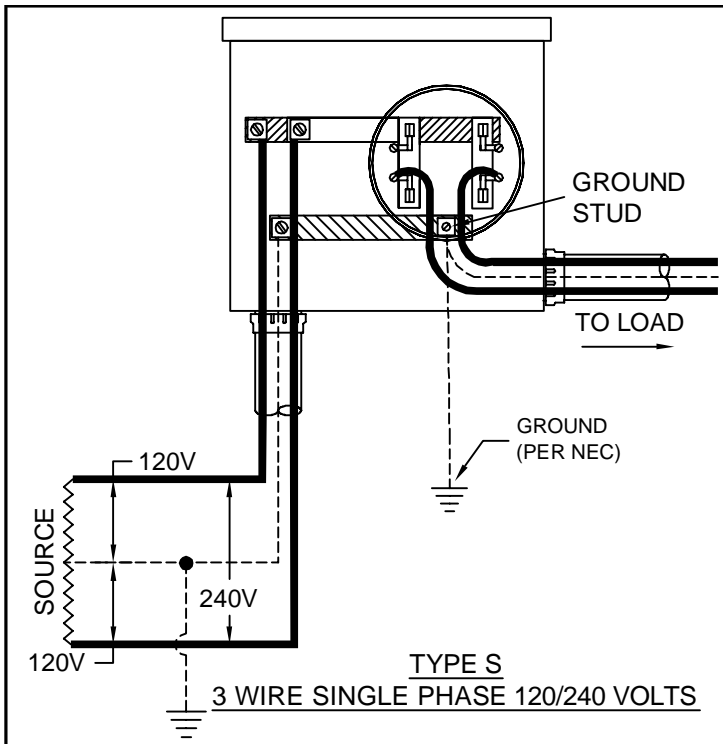

Notes:

1. All diagrams on this drawing show connections when the switch is installed on the right side (see Right Side below) of the meter socket. If the switch is installed on the left side of the meter socket you will need to mirror this diagram (see Left Side below).
2. All sockets, except residential single phase less than 320 Amps, shall have a manual mechanical gang operated bypass switch.
3. Load and supply wires shall not cross in the meter socket.

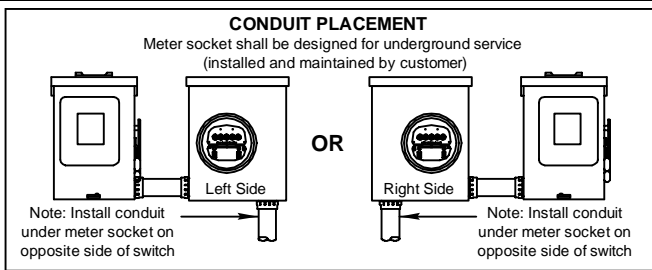

ENTERGY SERVICES, INC.

WIRING DIAGRAM CONNECTIONS FOR UNDERGROUND SELF CONTAINED METERS

APPROVED BY:	JRH	DATE:	01/10/2013
CHECKED BY:	JED	SCALE:	NONE
DRAWN BY:	krich95		

1	01/13	REVISION OF DRAWING SS11.8-2	EJH
NO.	DATE:	REVISION	BY: APPR:

Entergy

No. D9-3

PLOT 1=1 SH. 2 OF 2

Shall meet requirements of drawings D4-6, D9-3, D8-2, and either D8-4, or D8-5.

911 address shall be a minimum 3" lettering marked on meter enclosure, pole, or durable material attached to pole and should be visible from street. (See section 3.4)

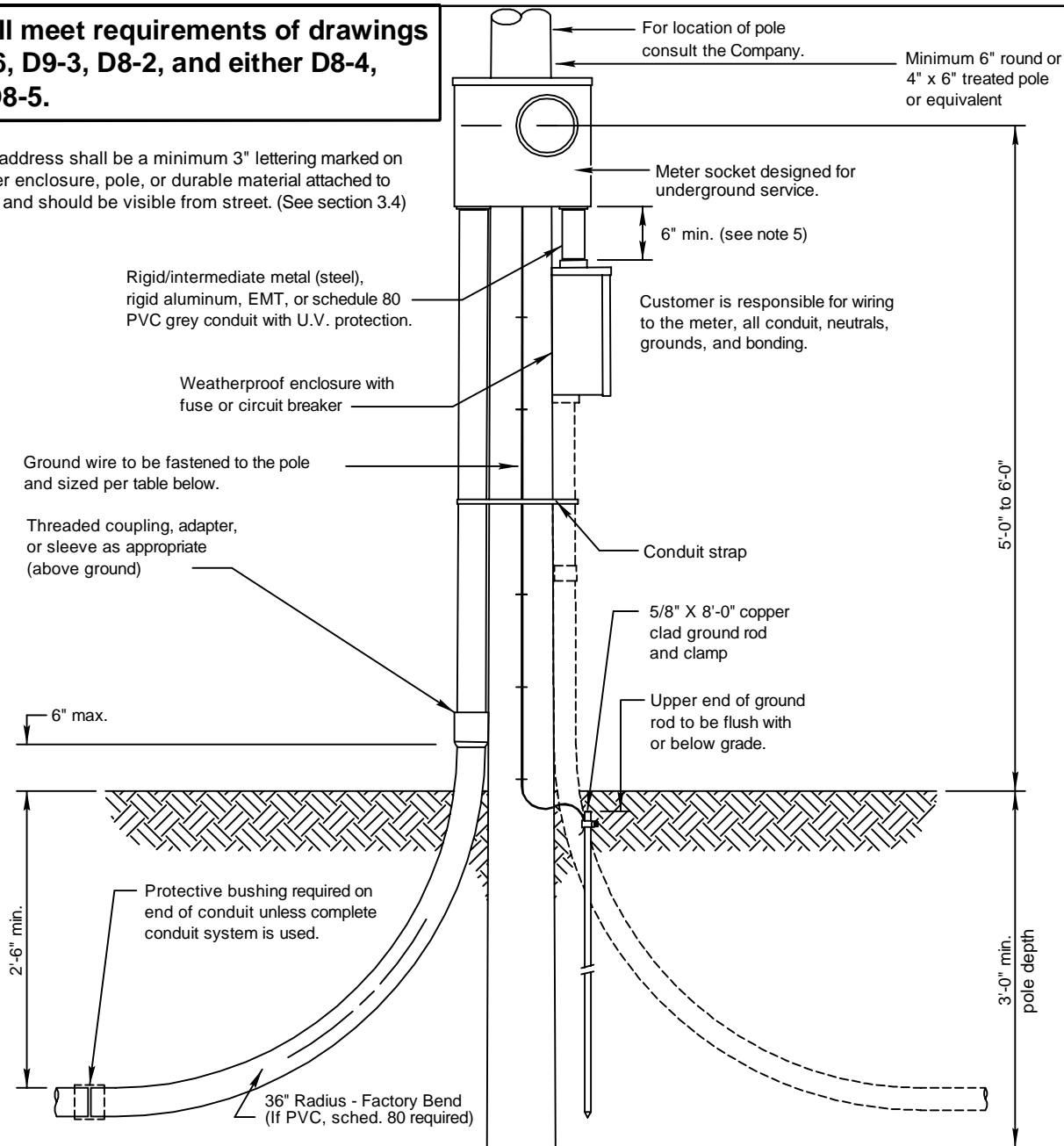

NOTES:

1. Customer facilities shall comply with Company Standards, the National Electrical Code, and authorities having jurisdiction.
2. All conduit connections to be raintight.
3. When installing conduit system, customer shall extend conduit to pole or underground system. Consult the company for details. (See drawings D8-4 and D8-5).
4. Location of underground cables shall be identified prior to digging.
5. If the conduit between the meter socket and the main disconnect is not metal, a bonding ground is required.

Minimum Customer Wiring Size - Family Residence Single Phase **

METER SIZE	CONDUIT SIZE	Current carrying & neutral wire size (per NEC)		GROUND WIRE SIZE
		ALUMINUM	COPPER	
100 Amp	2"	#2	#4	#6 *
200 Amp	2.5" ***	4/0	2/0	#4
320 Amp	3"	500	350	#2

* Wire sizes based upon customer breaker size.

** For 3Ø, consult the Company Commercial & Industrial. Wire sizes are typically larger.

***Arkansas only 2" permitted.

CALL 811 TWO BUSINESS DAYS BEFORE YOU DIG

In locations with underground facilities, the Customer shall notify One Call and shall have One Call locate all underground facilities before digging. It shall be the responsibility of the Customer to stay clear of all underground facilities.

ENTERGY SERVICES, INC.

PERMANENT POLE - UNDERGROUND SERVICE TO LOCATION (EXAMPLE: MOBILE HOME)

APPROVED BY: JRH DATE: 02/20/2013
 CHECKED BY: JED SCALE: 3/4"=1'-0"
 DRAWN BY: krich95

No. D4-5



PLOT 1=1 SH. 1 OF 1

1	02/13	REVISION OF DRAWING SS4.6-3	JED	
NO.	DATE:	REVISION	BY:	APPR:

Shall meet requirements of drawings D4-5 and D9-3.

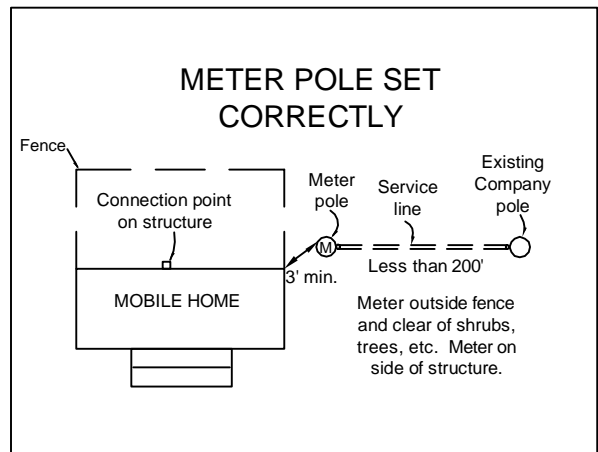
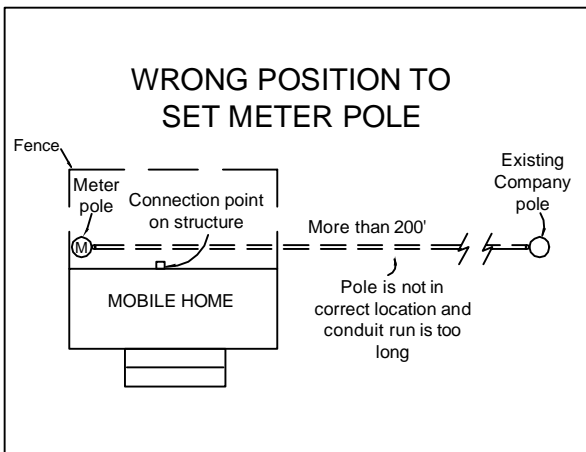

A Company approved Customer furnished and installed pedestal box may be required if length is more than 200' or if conduit installation has more than three (3) 90° bends, including bends in conduit on meter pole and utility pole.

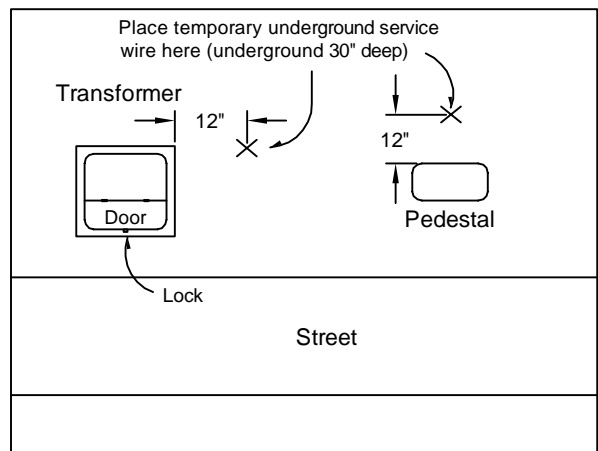
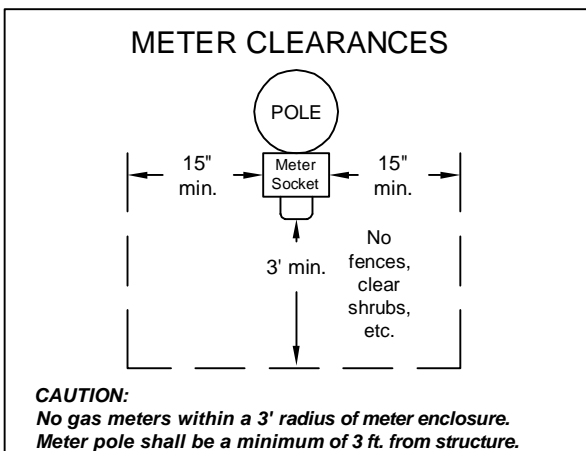
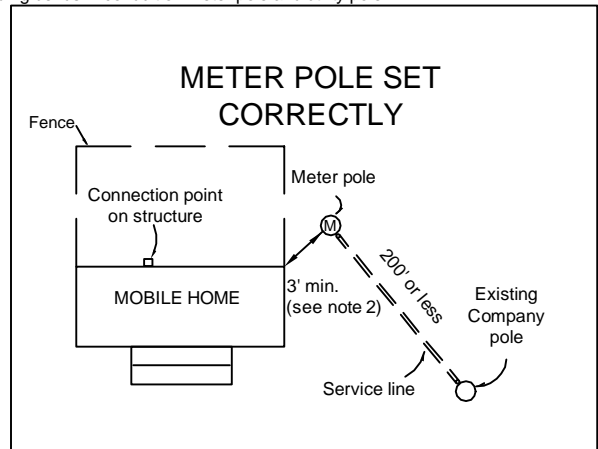
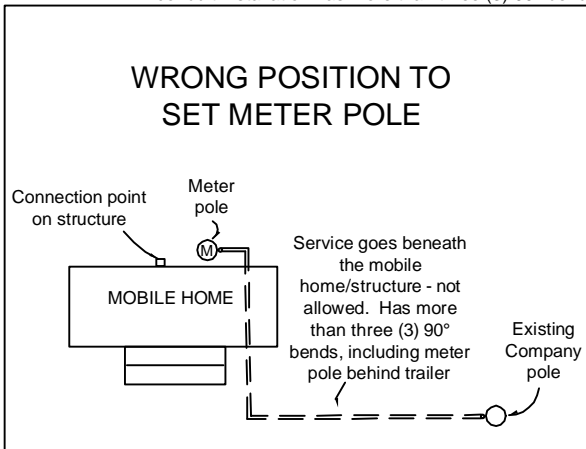

Call 811 Two Business Days Before You Dig

In locations with underground facilities, the Customer shall notify One Call and shall have One Call locate all underground facilities before digging. It shall be the responsibility of the Customer to stay clear of all underground facilities.

Notes:

1. Customer facilities shall comply with Company Standards, the National Electrical Code, and authorities having jurisdiction.
2. When installing conduit system, customer shall extend conduit to pole or underground system. Consult the company for details.
3. Company owned or maintained underground service shall **not** be installed beneath a mobile home or any other structure.
4. The customer is responsible for clearing and maintaining all right of way.

ENTERGY SERVICES, INC.	
PERMANENT POLE - UNDERGROUND SERVICE DETAILS FOR SINGLE MOBILE HOME OR STRUCTURE	
APPROVED BY: JRH	DATE: 10/23/2012
CHECKED BY: JED	SCALE: None
DRAWN BY: krich95	
No. D4-6	
PLOT 1=1 SH. 1 OF 1	

1	10/12	REVISION OF DRAWING SS4.6-4	JED	
NO.	DATE:	REVISION	BY:	APPR:



TYPICAL PULL BOX PEDESTAL

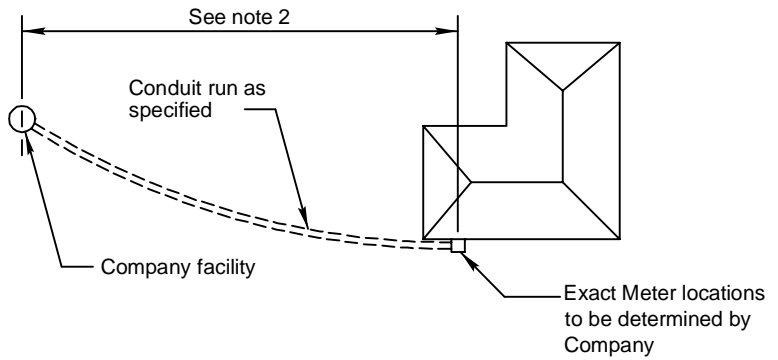
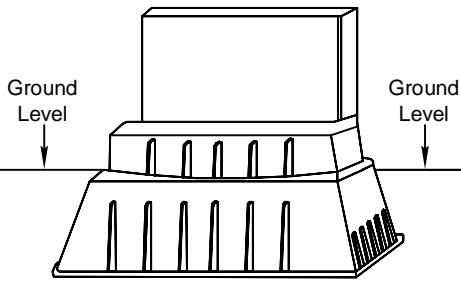

STANDARD SERVICE INSTALLATION

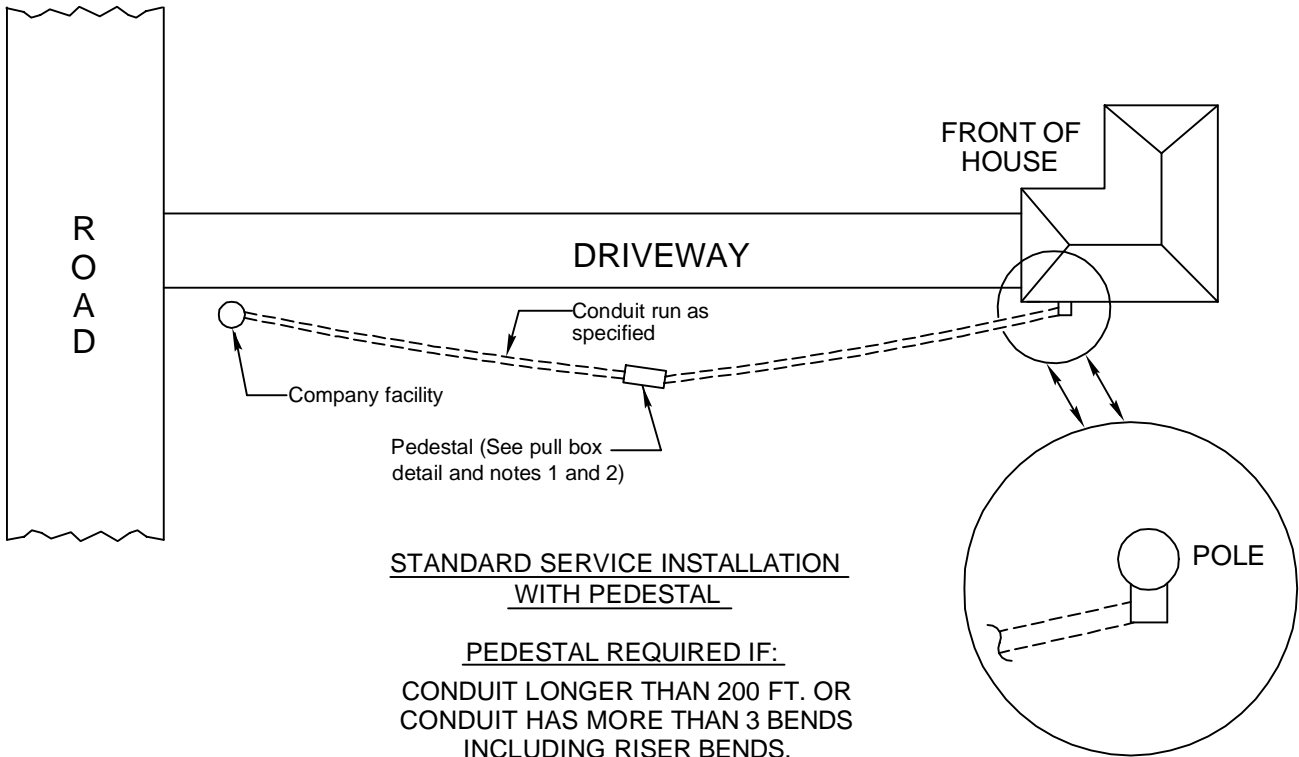

STANDARD SERVICE INSTALLATION WITH PEDESTAL

**PEDESTAL REQUIRED IF:
CONDUIT LONGER THAN 200 FT. OR
CONDUIT HAS MORE THAN 3 BENDS
INCLUDING RISER BENDS.**

**CALL 811 TWO BUSINESS
DAYS BEFORE YOU DIG**

In locations with underground facilities, the Customer shall notify One Call and shall have One Call locate all underground facilities before digging. It shall be the responsibility of the Customer to stay clear of all underground facilities.

Notes:

1. Customer shall consult with Company for location and type of pedestal.
2. The Customer shall bear the cost of conduit and its installation.

ENTERGY SERVICES, INC.

**TYPICAL CONDUIT SYSTEM
REQUIREMENTS FOR SECONDARY PHASE
CUSTOMER UNDERGROUND SERVICE**

APPROVED BY: JRH	DATE: 10/31/2012
CHECKED BY: JED	SCALE: NONE
DRAWN BY: krich95	

No. D8-2

1	10/12	REVISION OF DRAWING SS8.6-1	JED	
NO.	DATE:	REVISION	BY:	APPR:



PLOT 1=1 SH. 1 OF 1

Shall meet requirements of drawing D10-1.

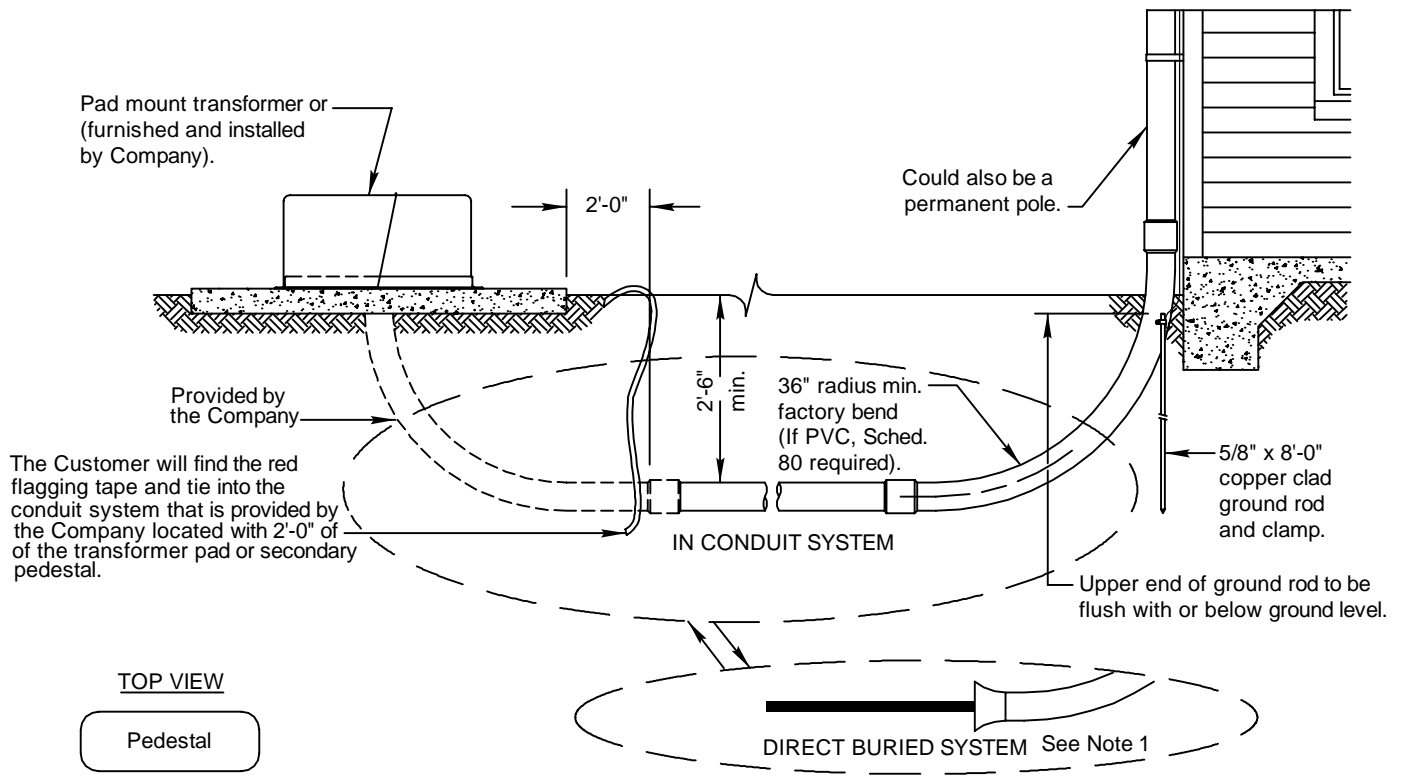

Street Side

Bring cable or conduit to one foot from the center of the pedestal buried at 30" below the ground.

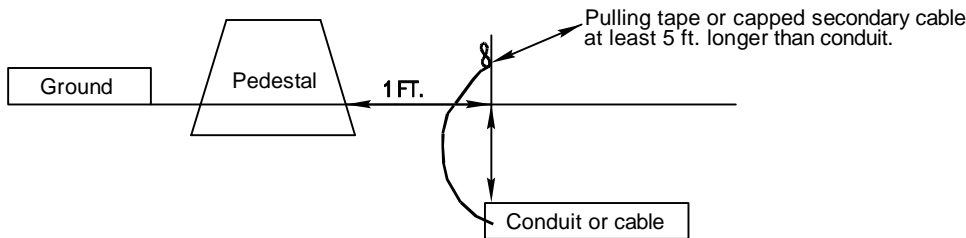

For direct buried, cable must be long enough to reach the connectors in the pedestal (at least 5 extra feet).

For Customer installed and supplied conduit, pulling tape must be long enough to reach pedestal (at least 5 extra feet) and the elbow to enter the pedestal is supplied by the Customer and installed by the Company.

CALL 811 TWO BUSINESS DAYS BEFORE YOU DIG

In locations with underground facilities, the Customer shall notify One Call and shall have One Call locate all underground facilities before digging. It shall be the responsibility of the Customer to stay clear of all underground facilities.

Notes:

- 1. Contact Company for local area requirements.

ENTERGY SERVICES, INC.			
PADMOUNT TRANSFORMER OR SECONDARY PEDESTAL SERVING A CUSTOMER			
APPROVED BY:	JRH	DATE:	11/06/2012
CHECKED BY:	JED	SCALE:	3/8"=1'-0"
DRAWN BY:	krich95		
		No. D8-4	
PLOT	1=1	SH.	1 OF 1

1	10/12	REVISION OF DRAWING SS8.6-2	JED	
NO.	DATE:	REVISION	BY:	APPR:

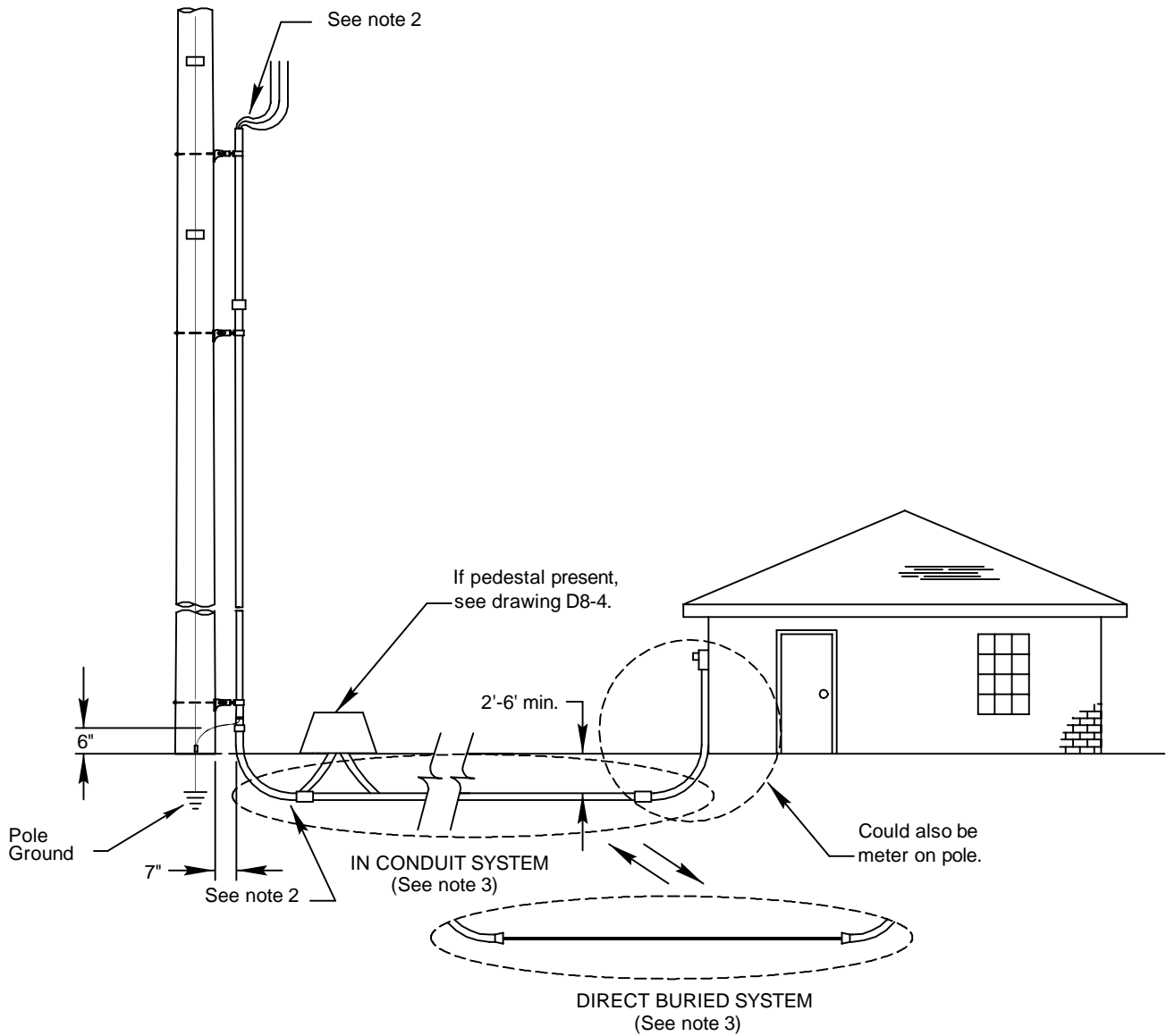

Notes:

1. If one conduit installation is already on the pole, Contact the Company to (at its option) install a pedestal at the base of the pole.
2. Customer shall install the conduit to 7" from the pole. The Company will install the Customer supplied riser material up the pole. The Customer shall supply enough conduit to extend up the pole to a point 50" above the Telephone Co.'s and/or cable. When these minimum conditions cannot be satisfied, the Customer shall consult the Company. The Customer shall secure the riser material at the meter entrance for installation by the Company. **(EXCEPTION: In Arkansas and Mississippi the conduit for the riser is supplied by the Company)**
3. Contact Company for local area requirements.

CALL 811 TWO BUSINESS DAYS BEFORE YOU DIG

In locations with underground facilities, the Customer shall notify One Call and shall have One Call locate all underground facilities before digging. It shall be the responsibility of the Customer to stay clear of all underground facilities.

ENTERGY SERVICES, INC.

TYPICAL UNDERGROUND SERVICE FROM OVERHEAD SOURCE

APPROVED BY: JRH	DATE: 11/06/2012
CHECKED BY: JED	SCALE: NONE
DRAWN BY: krich95	

No. D8-5

1	10/12	REVISION OF DRAWING SS8.6-3	JED	
NO.	DATE:	REVISION	BY:	APPR:



PLOT 1=1 SH. 1 OF 1